

URBANO

Concrete Retaining Wall

PERMACON

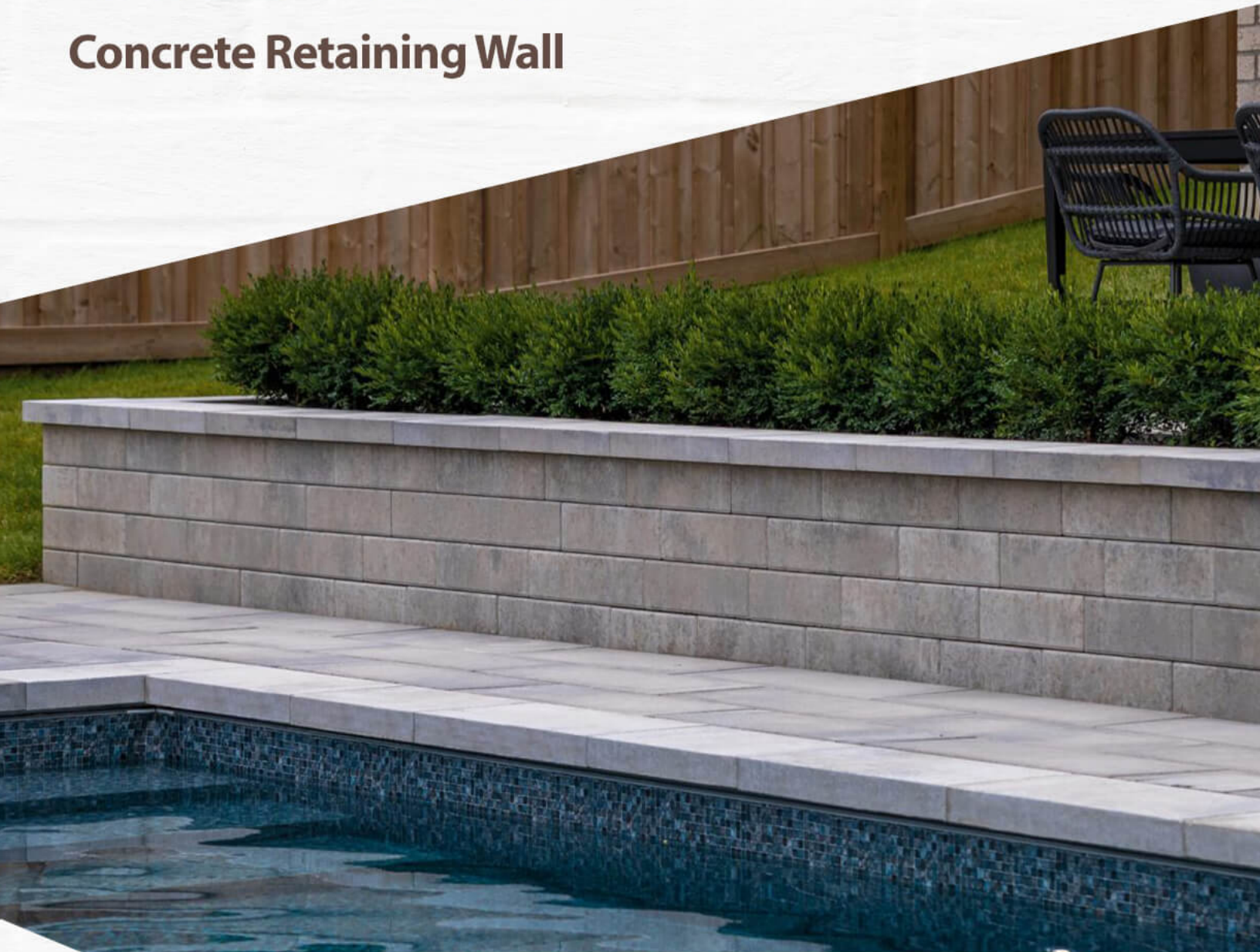

Installation Guide

VB
VAN BEEK'S
LANDSCAPE SUPPLY

www.vanbeeks.com

Urbano Wall™

DESCRIPTION



Offering a contemporary look, the Urbano wall is distinguished by its refined, elongated formats and varying lengths. The integrated corner of each wall unit allows you to design a high-quality landscape project. With the Urbano wall, you can also quickly create flowerbeds or firepits. Available in trendy colors, the Urbano wall helps to enhance any landscape design.

ADVANTAGES:

- > Modern and refined finish
- > Quick and easy to install
- > Integrated corner on each unit
- > 120 mm height with multiple lengths for a slim design
- > Available in three trendy colours

UNITS

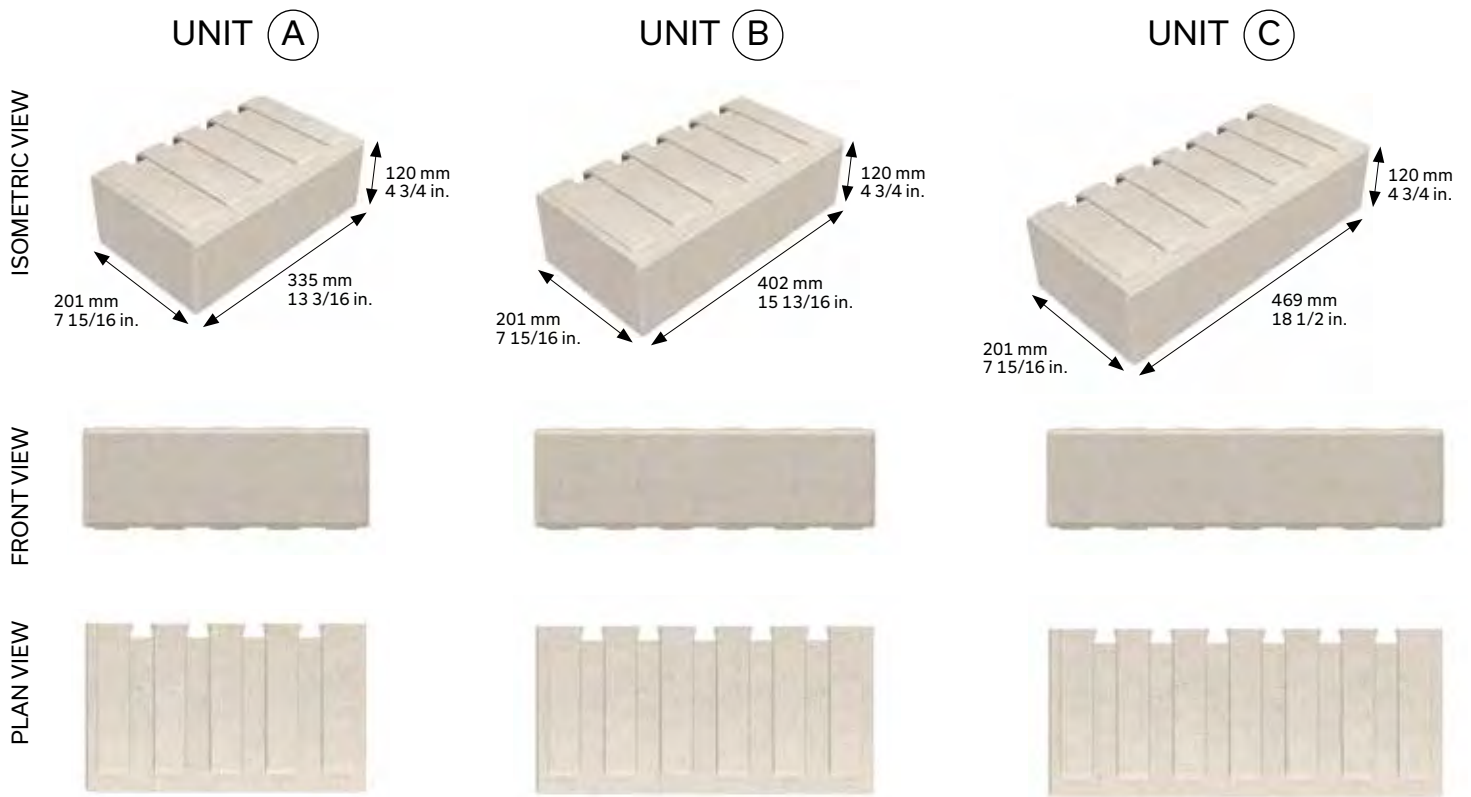

Note that units A, B and C are packaged on the same cube.

LAYING PATTERN

LINEAR PATTERN

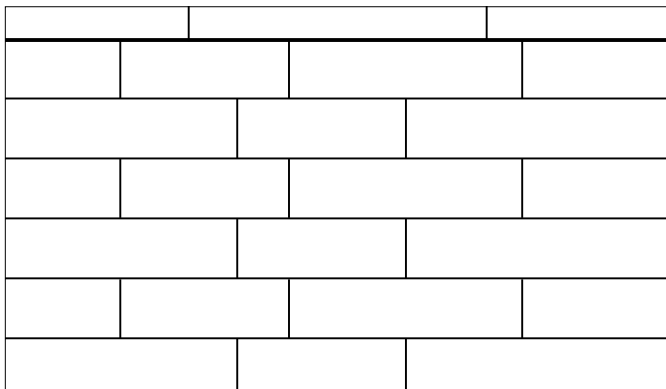

BASIC PRINCIPLES

Universal anchor that fits into the dovetails.
Vertical or setback installation.

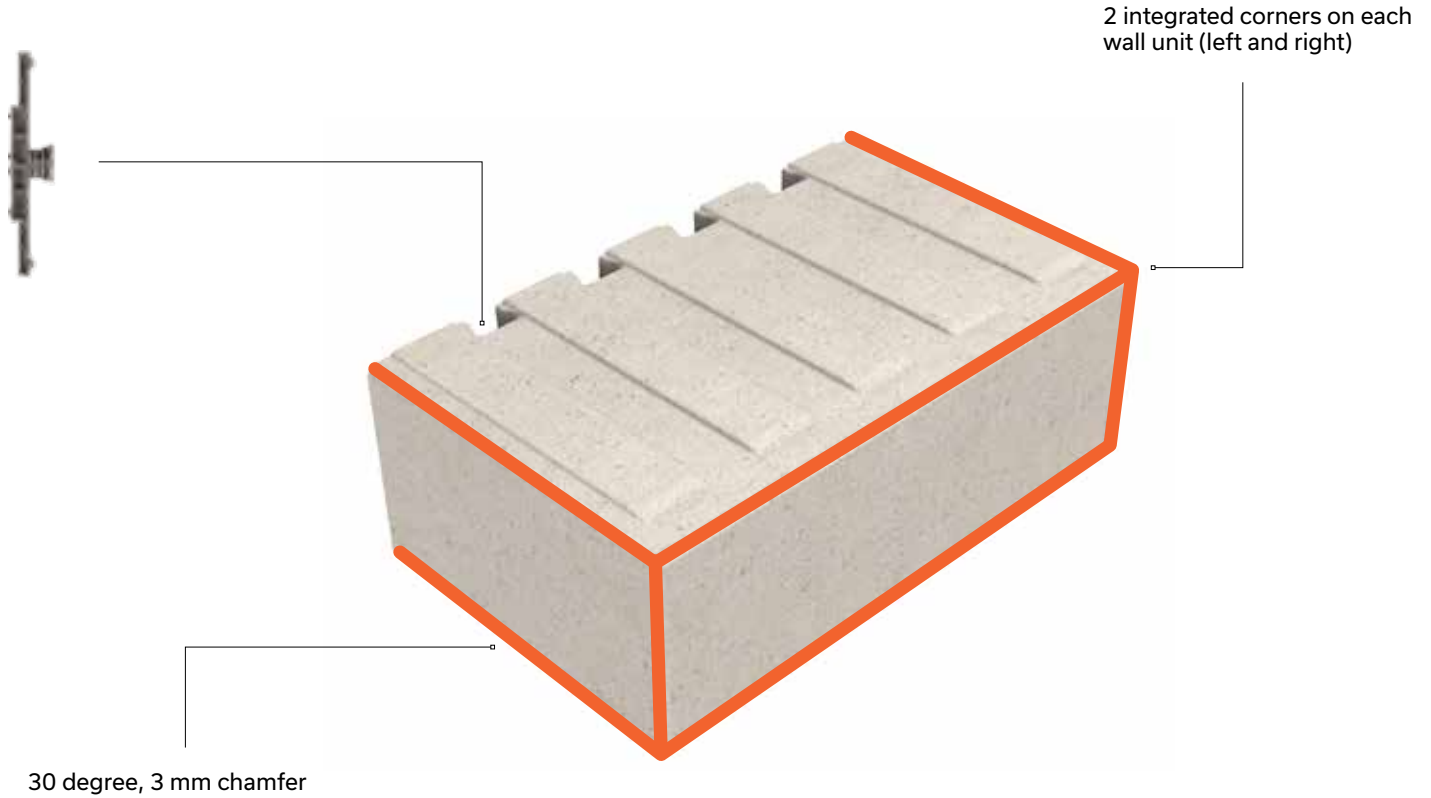

UNIVERSAL ANCHOR

The Urbano wall anchoring system is designed to facilitate the construction of a vertical or 3 degree setback wall. This anchoring system enables the installation and alignment of the wall units. Note that the anchor box is located inside the pallet between the 2 central wooden slats as shown in the image below.



SETBACK WALL

The Urbano wall can be installed either vertically or with a setback using the universal anchor designed specifically for this purpose. This anchor is inserted into one of the grooves located at the back of the units. Anchors must be slid from the top of the grooves until they overlap the wall unit below by a few centimeters. Two universal anchors are generally recommended for each Urbano wall unit. To build a setback wall, the anchor must be placed as shown in the illustration in STEP 1. Once the anchor is in place, simply push the wall unit forward until the anchor locks it in place, creating a setback of approximately 8 mm from the lower unit.

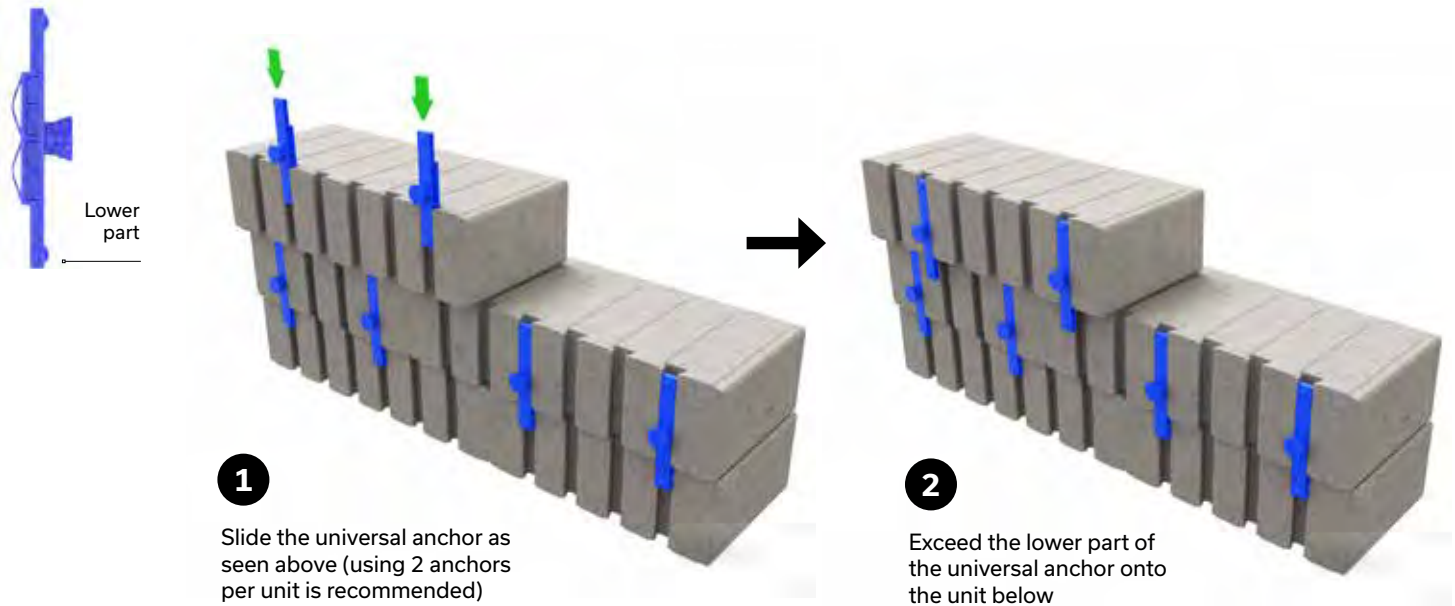

CROSS-SECTION VIEW

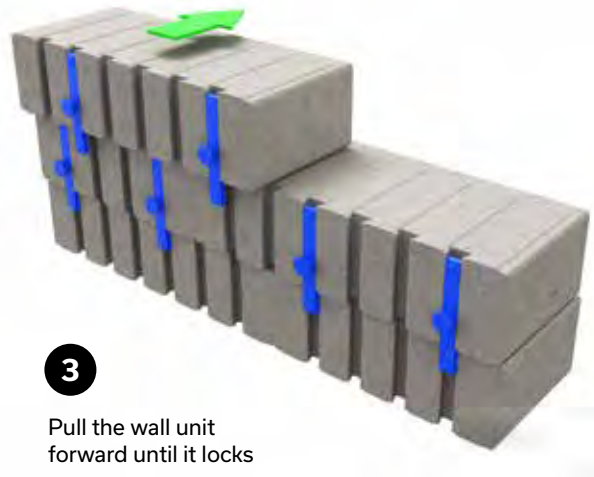

VERTICAL WALL

The vertical wall applies the same principle as the setback wall except that the universal anchor is installed on the opposite side and must be rotated 45 degrees. The Urbano wall unit is then pushed forward until it locks, creating a vertical wall.

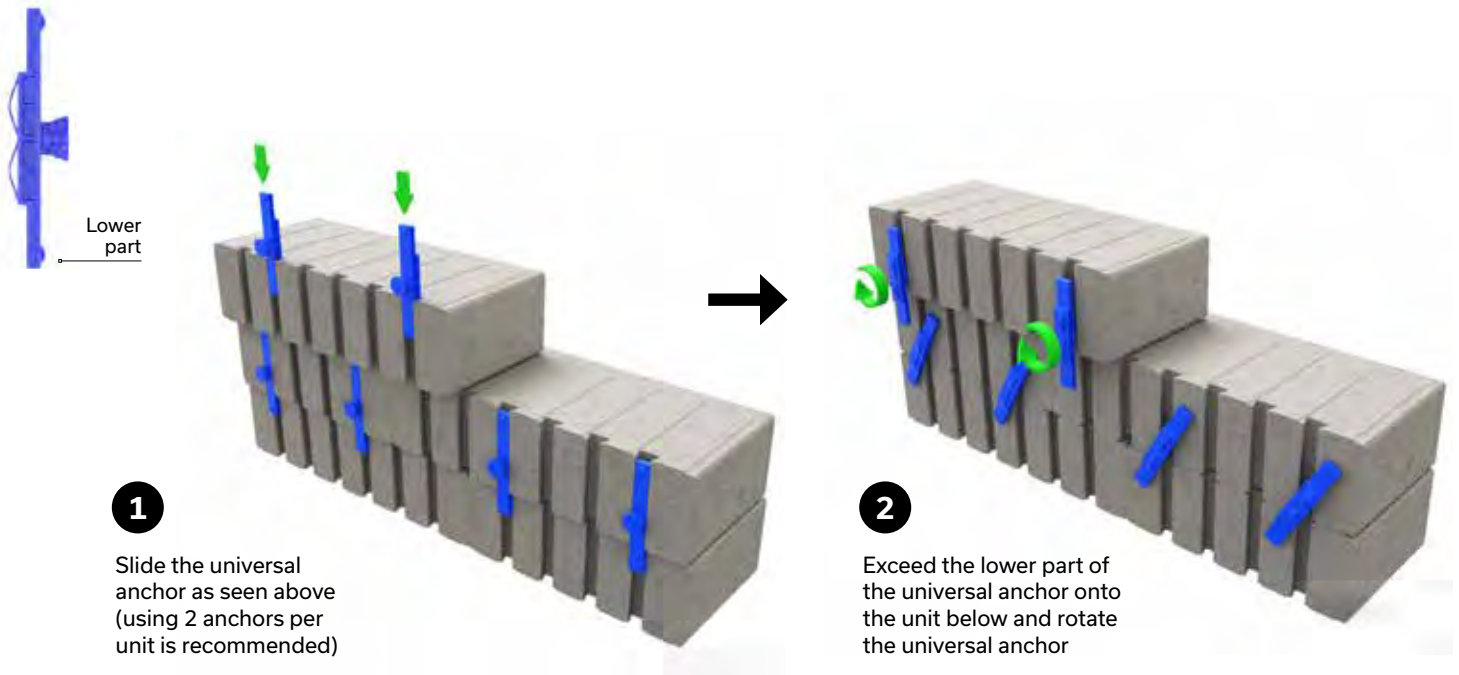

CROSS-SECTION VIEW

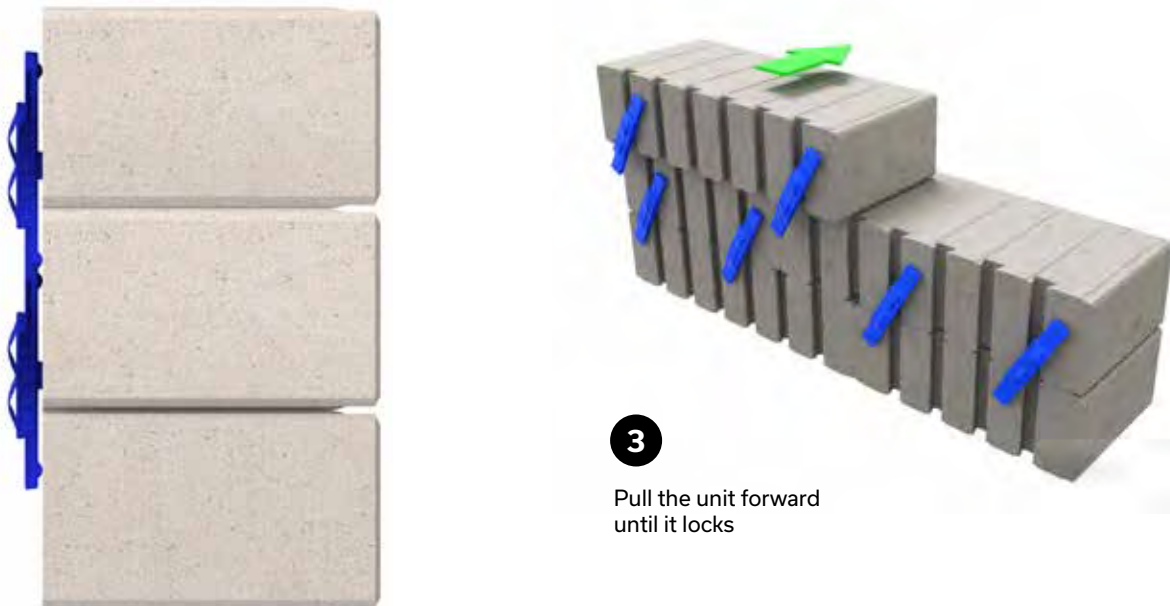

URBANO WALL

CROSS-SECTION -SETBACK WALL

The following is a general cross-section of an Urbano wall construction. The height of an Urbano wall unit is 120 mm - 4 3/4 in. The maximum height of the setback Urbano wall is 6 rows.

ISOMETRIC VIEW

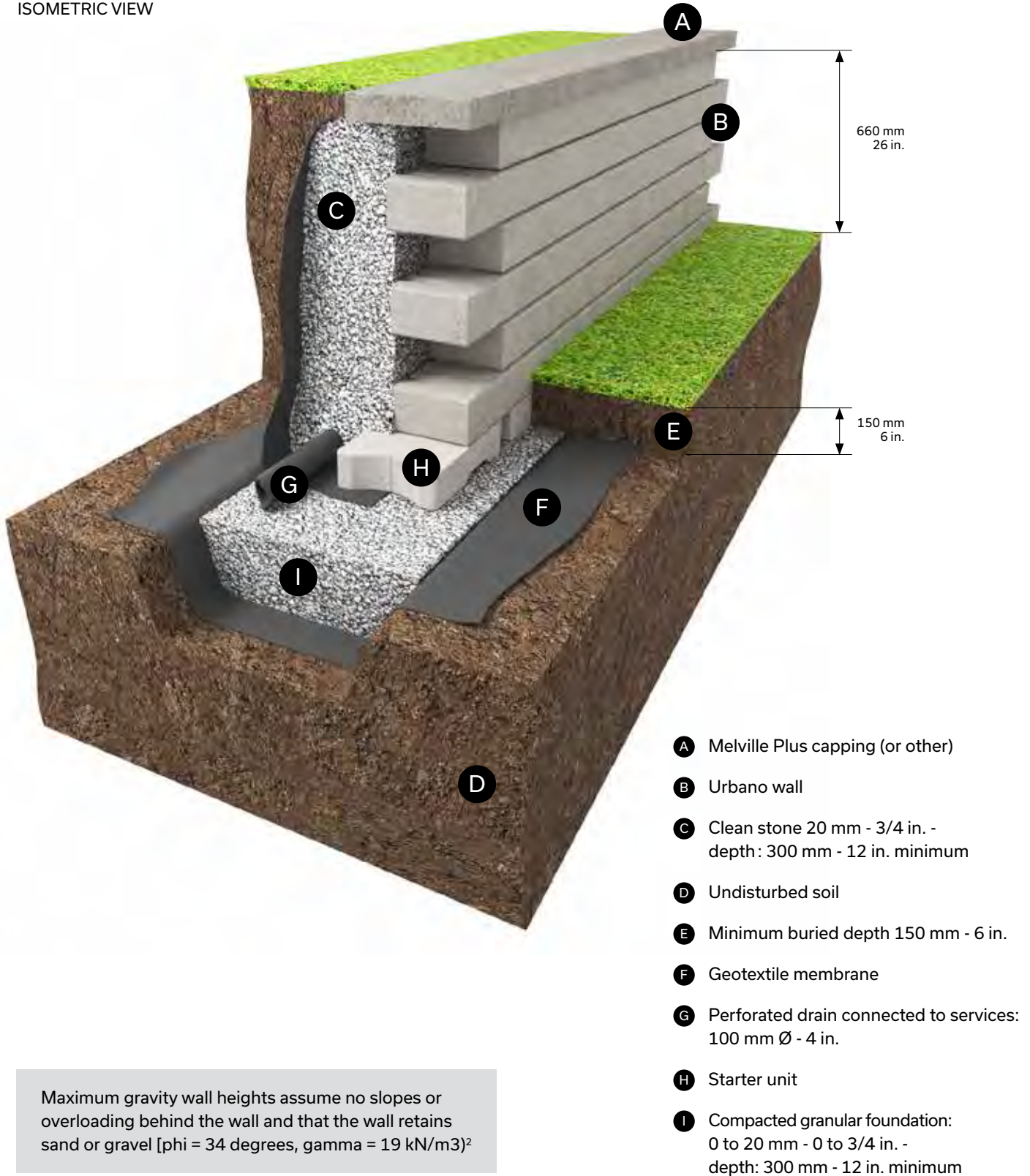

Maximum gravity wall heights assume no slopes or overloading behind the wall and that the wall retains sand or gravel [$\phi = 34$ degrees, $\gamma = 19 \text{ kN/m}^3$]

CROSS-SECTION -SETBACK GRAVITY WALL

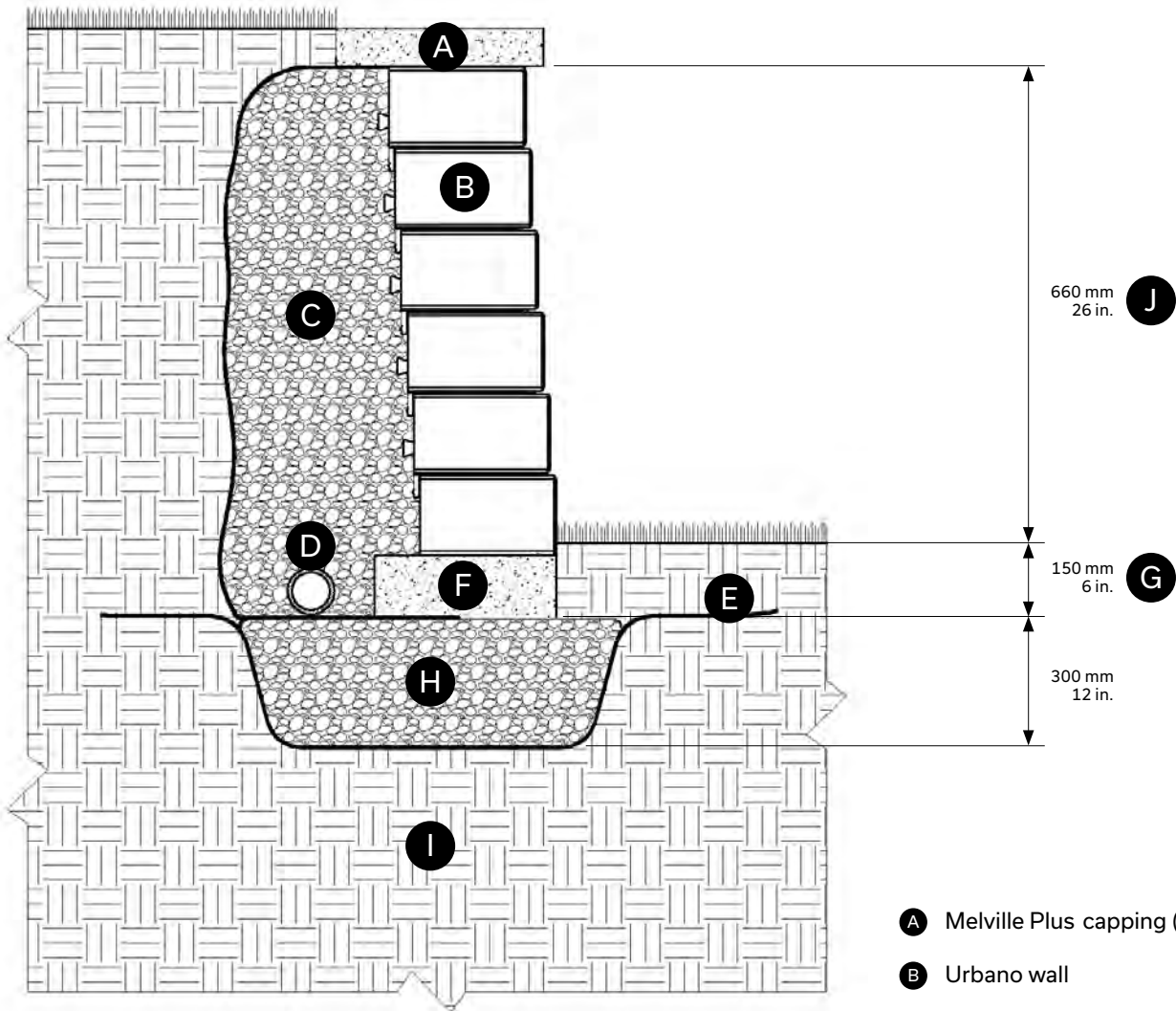

- Ⓐ Melville Plus capping (or other)
- Ⓑ Urbano wall
- Ⓒ Clean stone 20 mm - 3/4 in. - depth: 300 mm - 12 in. minimum
- Ⓓ Perforated drain connected to services: 100 mm Ø - 4 in.
- Ⓔ Geotextile membrane
- Ⓕ Starter unit
- Ⓖ Minimum buried depth 150 mm - 6 in.
- Ⓗ Compacted granular foundation: 0 to 20 mm - 0 to 3/4 in. - depth: 300 mm - 12 in. minimum
- Ⓘ Undisturbed soil
- Ⓙ Maximum height without surcharges or slopes behind the wall, excluding the buried units and capping

Maximum gravity wall heights assume no slopes or overloading behind the wall and that the wall retains sand or gravel [$\phi = 34$ degrees, $\gamma = 19 \text{ kN/m}^3$]

URBANO WALL

CROSS-SECTION - VERTICAL WALL

The maximum height of the Urbano vertical wall is 5 rows.

ISOMETRIC VIEW

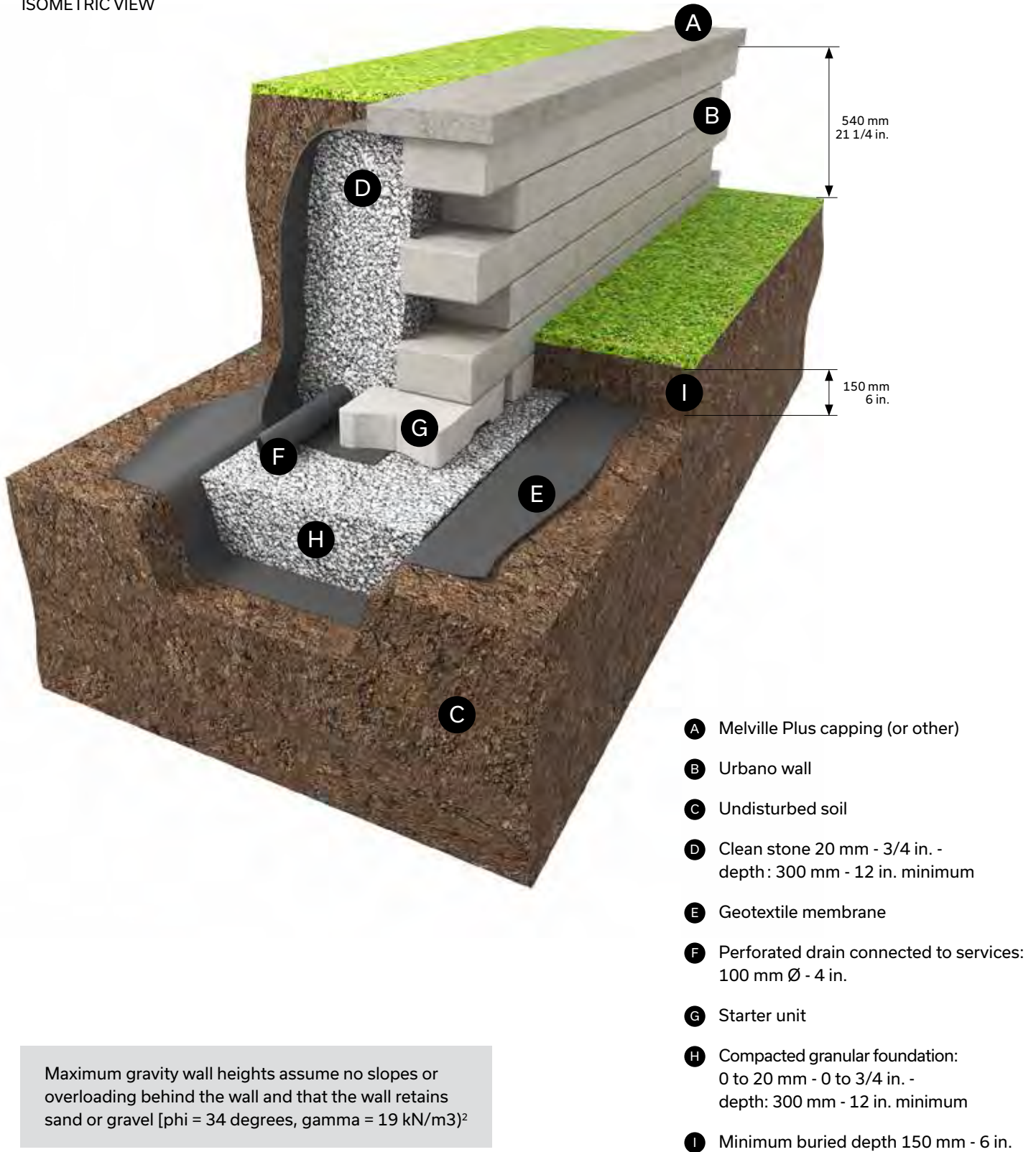

Maximum gravity wall heights assume no slopes or overloading behind the wall and that the wall retains sand or gravel [$\phi = 34$ degrees, $\gamma = 19$ kN/m³]²

CROSS-SECTION - VERTICAL GRAVITY WALL

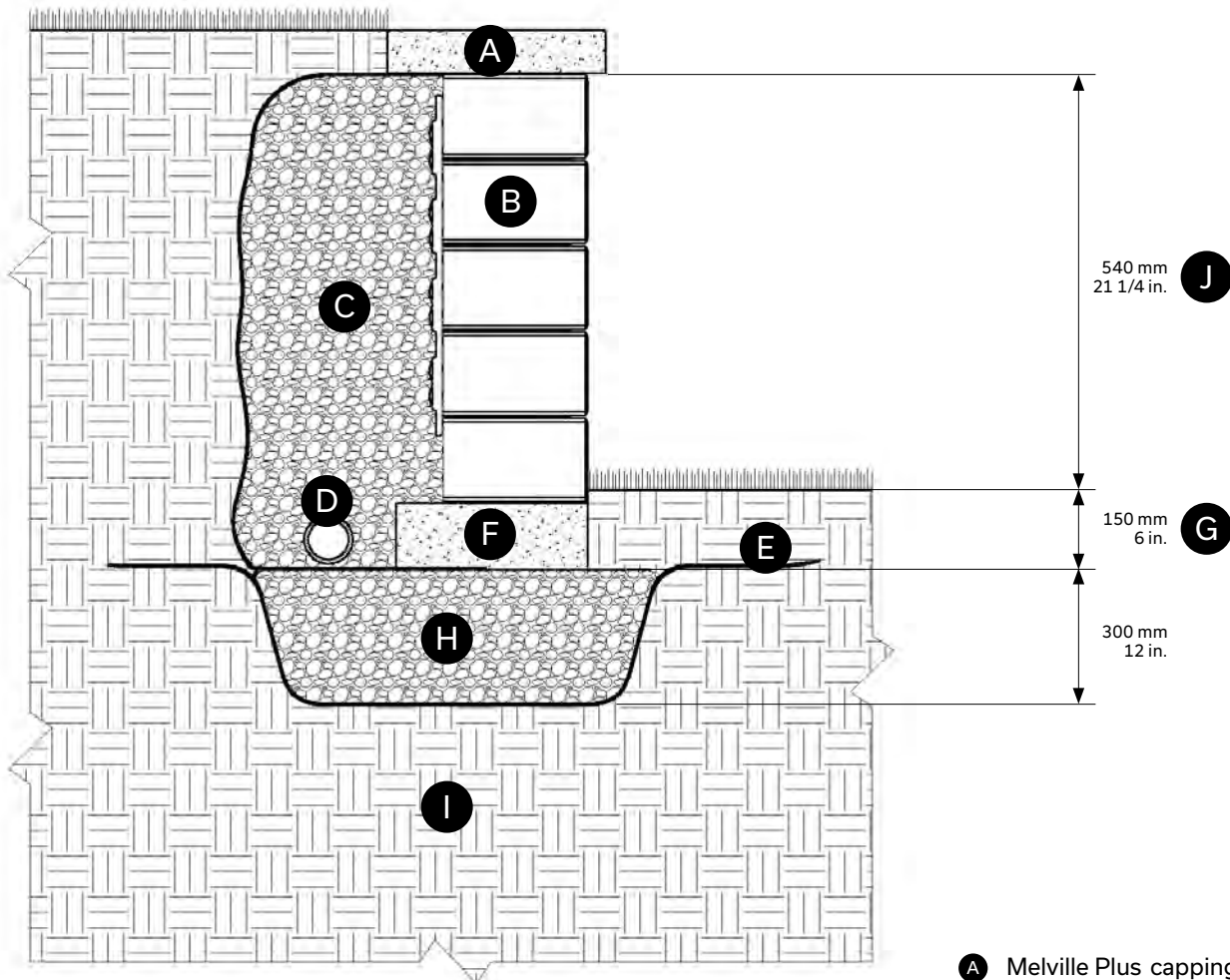

- Ⓐ Melville Plus capping (or other)
- Ⓑ Urbano wall
- Ⓒ Clean stone 20 mm - 3/4 in. - depth: 300 mm - 12 in. minimum
- Ⓓ Perforated drain connected to services: 100 mm Ø - 4 in.
- Ⓔ Geotextile membrane
- Ⓕ Starter unit
- Ⓖ Minimum buried depth 150 mm - 6 in.
- Ⓗ Compacted granular foundation: 0 to 20 mm - 0 to 3/4 in. - depth: 300 mm - 12 in. minimum
- Ⓘ Undisturbed soil
- Ⓙ Maximum height without surcharges or slopes behind the wall, excluding the buried units and capping

Maximum gravity wall heights assume no slopes or overloading behind the wall and that the wall retains sand or gravel [$\phi = 34$ degrees, $\gamma = 19 \text{ kN/m}^3$]

CROSS-SECTION -CREATING URBANO WALL STEPS

To create stairs, install the Melville 60 step combined with the Urbano wall units used as risers, as detailed below:

ISOMETRIC VIEW

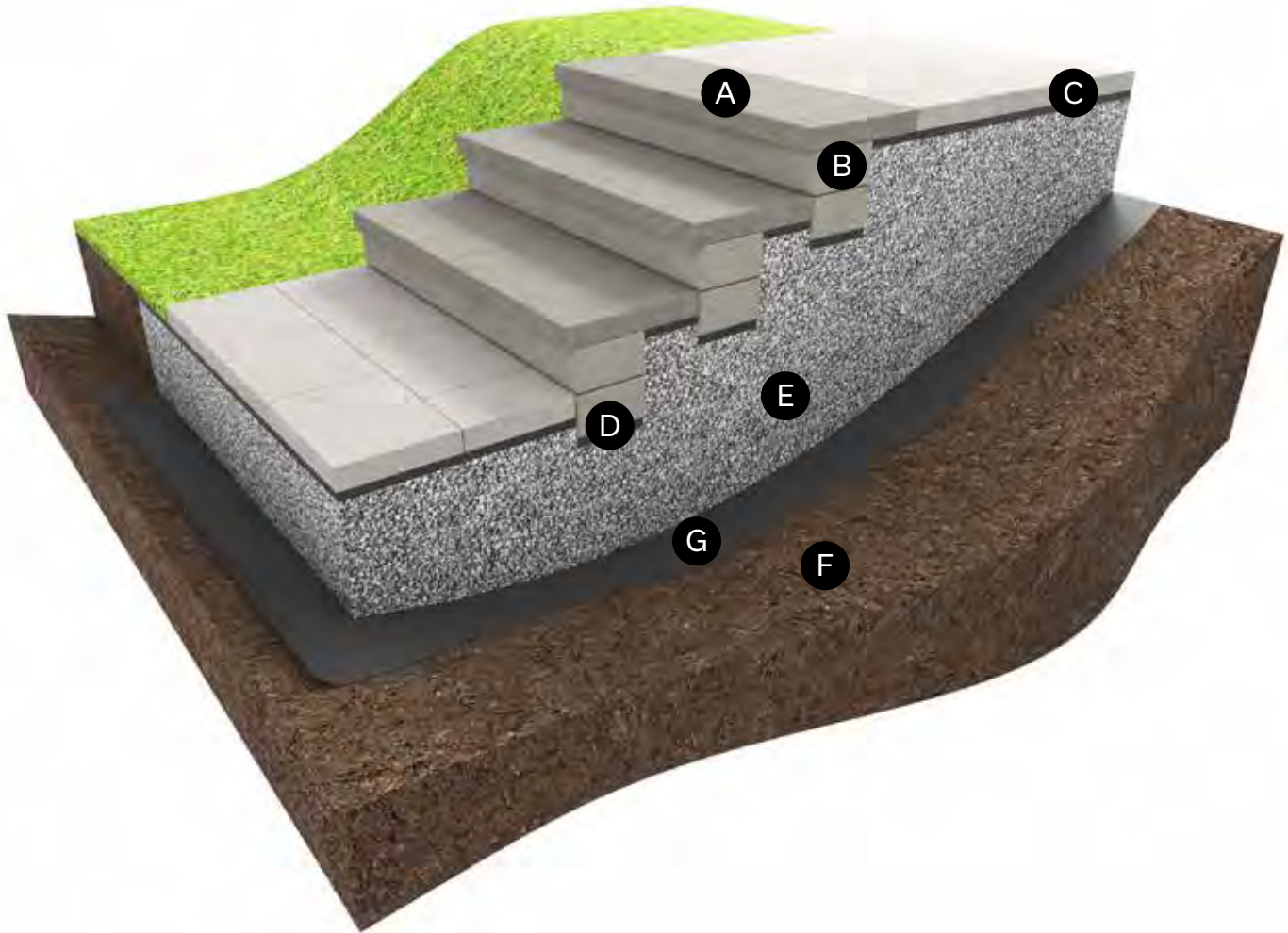

- A** Melville Plus capping (or other)
- B** Urbano wall
- C** Concrete slab: 60 mm -2 3/8 in.
- D** Laying bed: 25 mm -1 in.
- E** Compacted granular foundation:
0 to 20 mm - 0 to 3/4 in. -
depth: 300 mm - 12 in. minimum
- F** Soil in place
- G** Geotextile membrane

All step and riser units must be bonded together with Techniseal concrete adhesive.

CROSS-SECTION - WALL STEP INSTALLATION

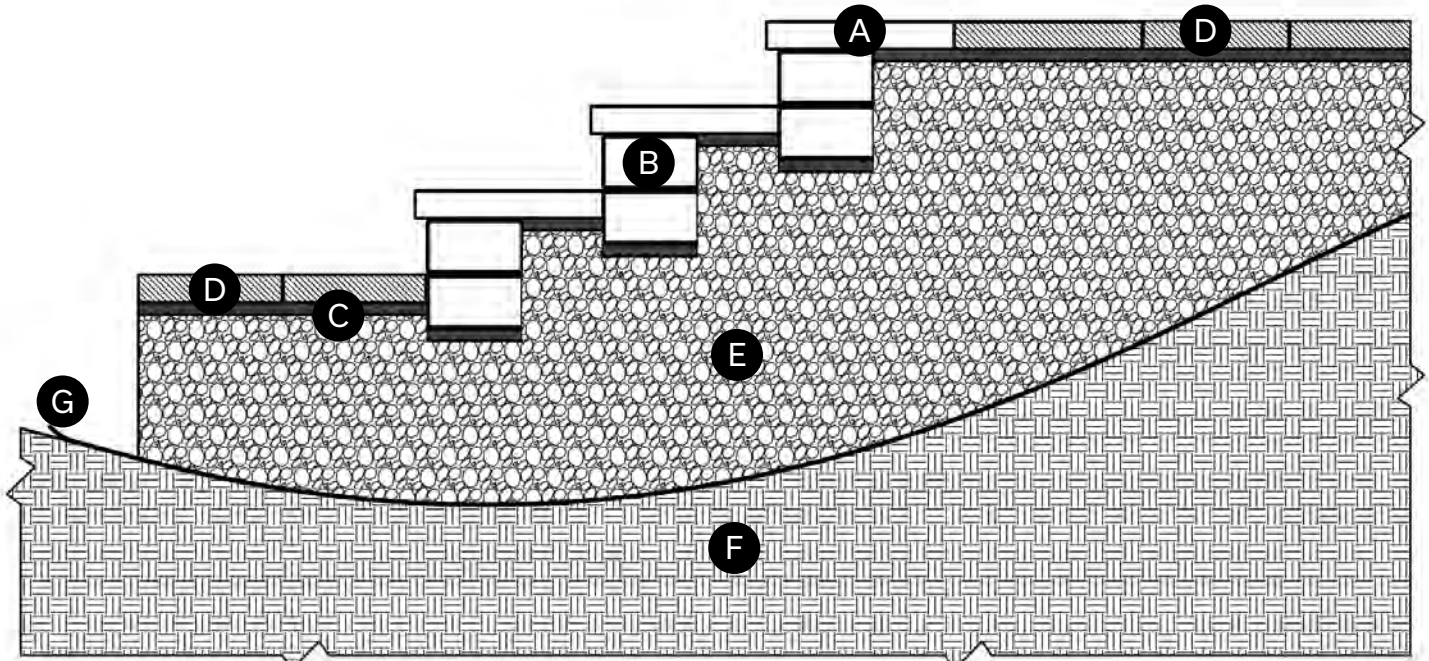

- Ⓐ Melville Plus 60 step unit
- Ⓑ Urbano wall
- Ⓒ Laying bed: 25 mm -1 in.
- Ⓓ Concrete slab: 60 mm -2 3/8 in.
- Ⓔ Compacted granular foundation:
0 to 20 mm - 0 to 3/4 in. -
depth: 300 mm - 12 in. minimum
- Ⓕ Soil in place
- Ⓖ Geotextile membrane

All step and riser units must be bonded together with Techniseal concrete adhesive.

CREATING OUTER AND INNER CORNERS

ISOMETRIC VIEW - OUTER CORNER

It is recommended to always begin the construction of a retaining wall with a corner in order to avoid cuts and an alignment of vertical joints from one row to another. All Urbano wall units can be used to create a corner.



ISOMETRIC VIEW - INNER CORNER

The creation of an inner corner is based on the principle illustrated below using units A, B or C.



BUILDING A SQUARE FIREPIT

The Urbano wall can be used to create many types of firepits: propane gas, natural gas, ethanol and wood. Construction begins with the installation of a proper foundation (levelled and densified). For a wood-burning firepit, a minimum 12 mm - 1/2 in. thick fiber cement board* or refractory firebrick* is recommended to ensure adequate protection. These elements must be installed all around the interior walls of the firepit.

For a gas fire pit, it is necessary to install conduits in the ground to carry the gas pipes or even electrical wires. The suggested size below is for reference; actual dimensions will vary depending on the selected unit.

ISOMETRIC VIEW

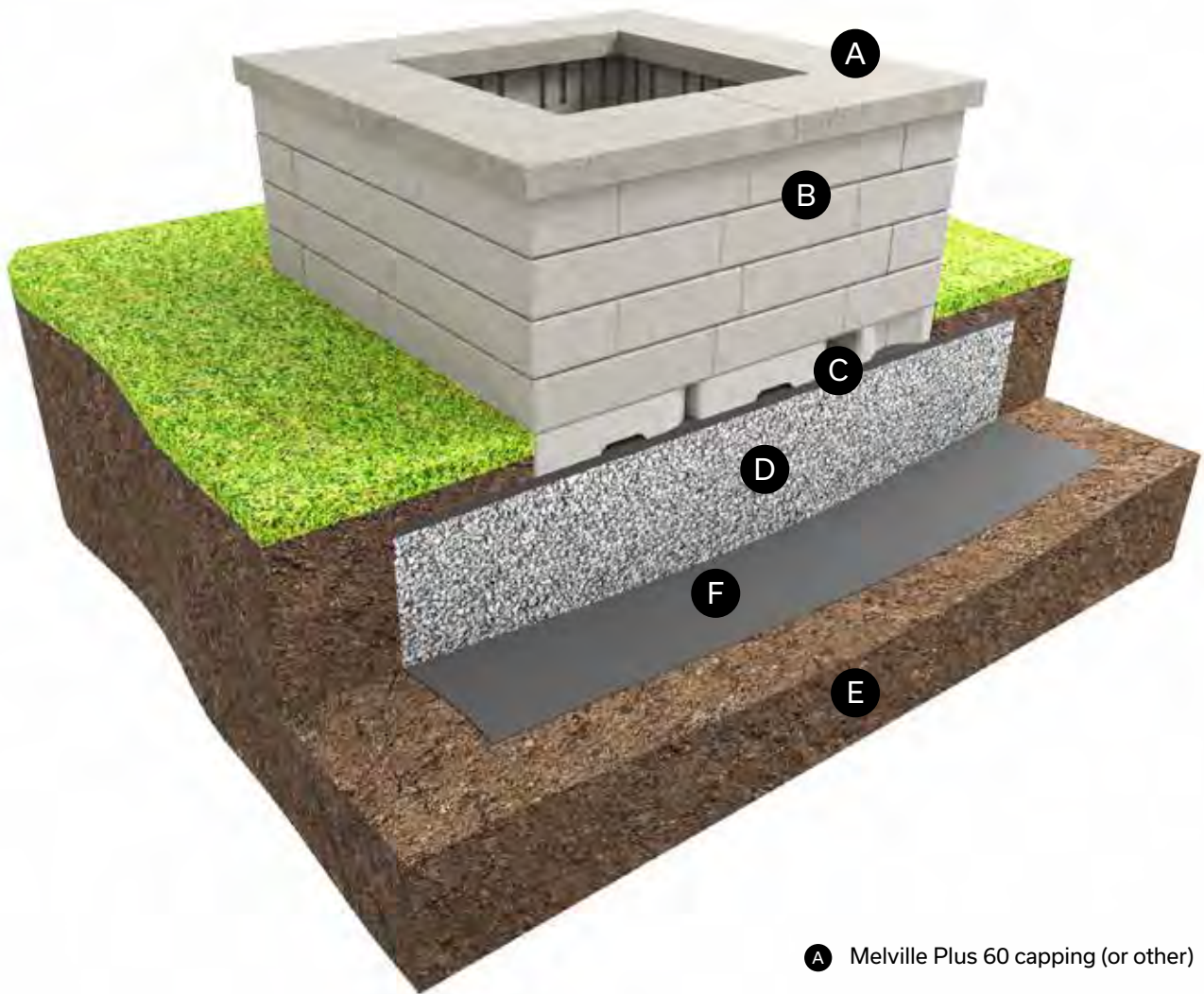

- A** Melville Plus 60 capping (or other)
- B** Urbano wall
- C** Laying bed 25 mm - 1 in.
- D** Compacted granular foundation:
0 to 20 mm - 0 to 3/4 in. -
depth: 300 mm - 12 in. minimum
- E** Soil in place
- F** Geotextile membrane

* Elements not shown in image

SQUARE FIREPIT- WALL UNITS INSTALLATION



1
Begin installation with starter units

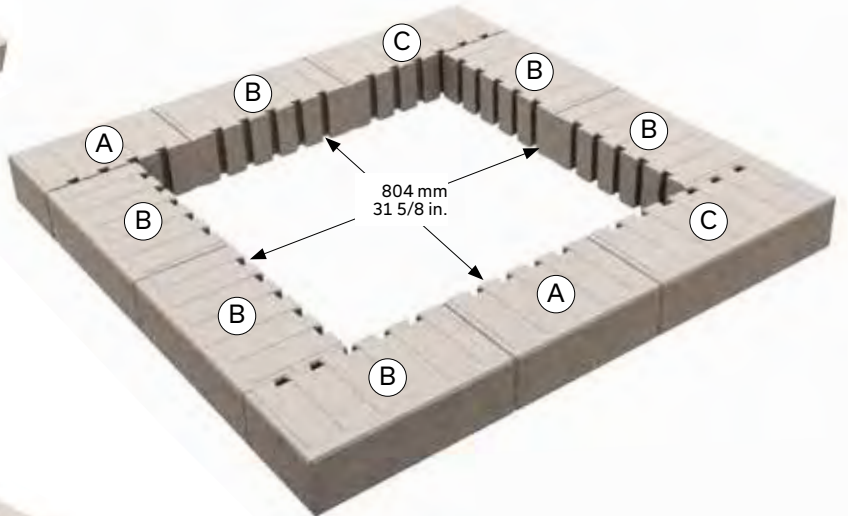

2
2nd row: install Urbano wall units by following this diagram

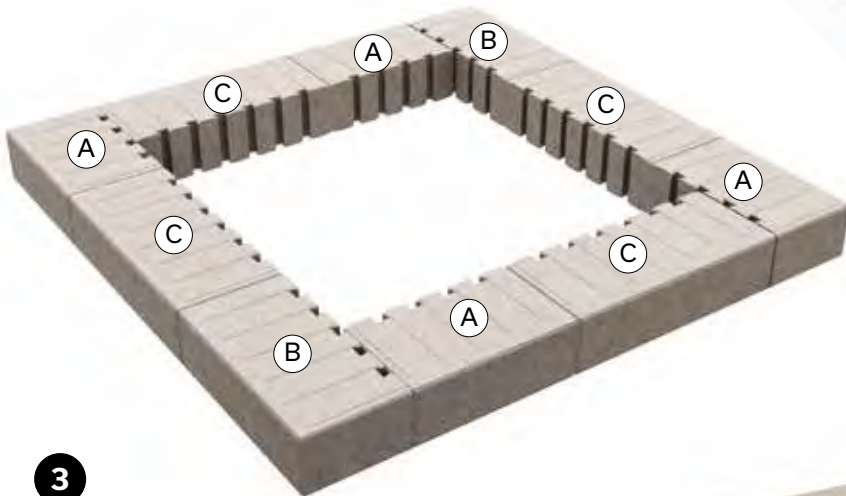

3
3rd row: proceed with installation by following this diagram

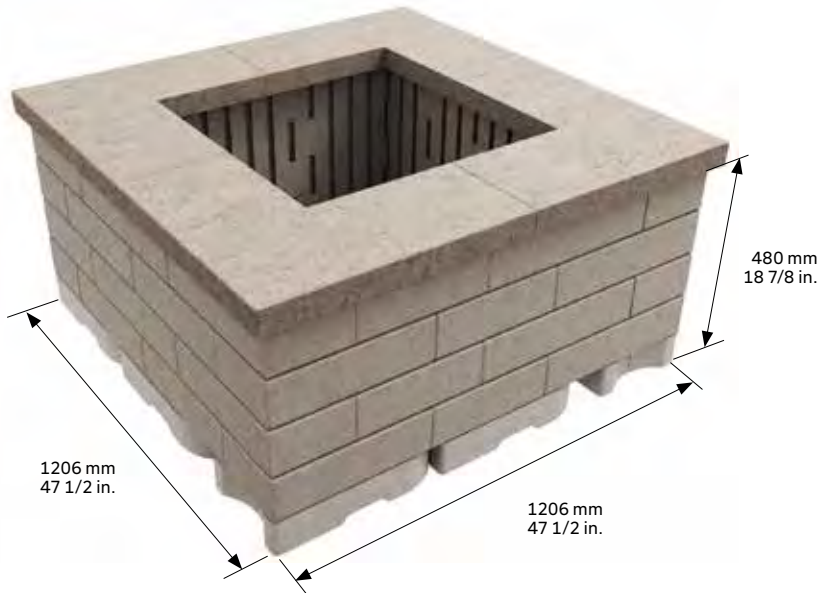

4
4th row: proceed with installation by repeating 2nd row diagram

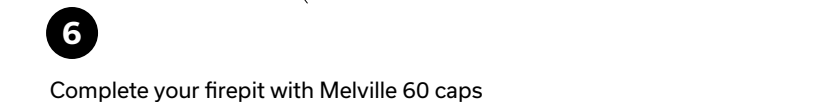

5
5th row: proceed with installation by repeating 3rd row diagram

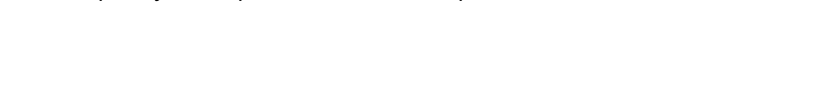

6
Complete your firepit with Melville 60 caps

BUILDING A RECTANGULAR FIREPIT

The rectangular format is primarily geared toward a propane or natural gas firepit. Its dimensions will need to be adapted according to the type of firepit selected. We recommend that you consult with a gas fitter or inquire about local codes and regulations before proceeding with a gas firepit installation.

In addition, it will be necessary to install conduits in the ground to carry gas pipes or even electrical wires, if required.

ISOMETRIC VIEW

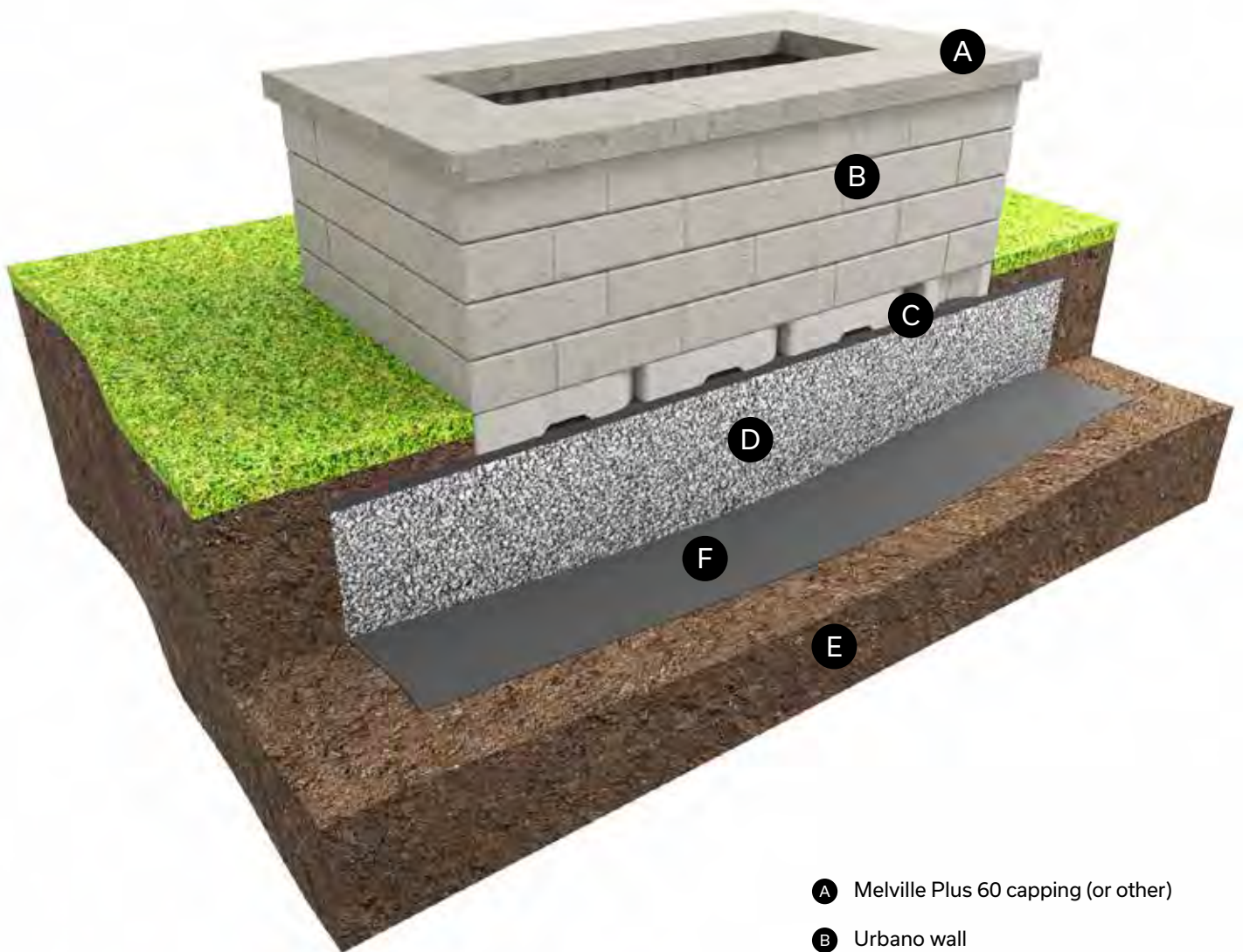

- Ⓐ Melville Plus 60 capping (or other)
- Ⓑ Urbano wall
- Ⓒ Laying bed 25 mm - 1 in.
- Ⓓ Compacted granular foundation:
0 to 20 mm - 0 to 3/4 in. -
depth: 300 mm - 12 in. minimum
- Ⓔ Soil in place
- Ⓕ Geotextile membrane

RECTANGULAR FIREPIT-WALL UNITS INSTALLATION



1

Begin installation with starter units

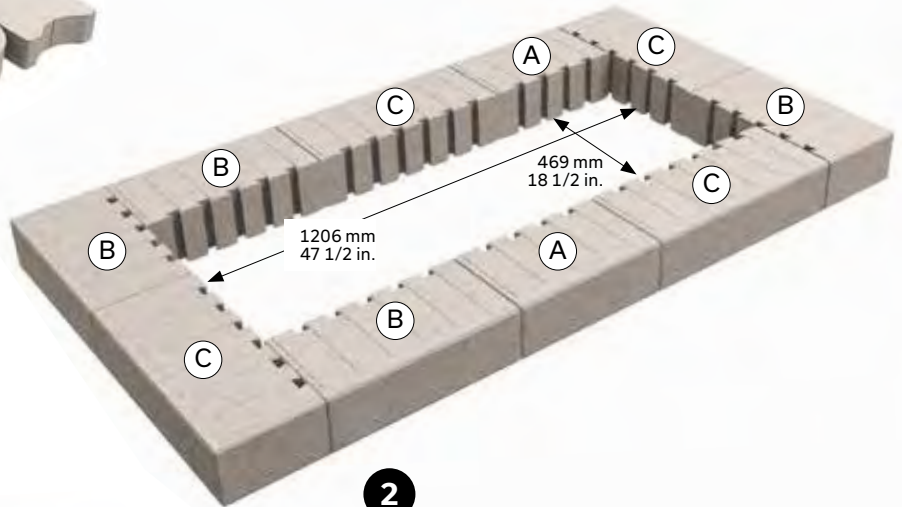

2

2nd row: install Urbano wall units by following this diagram

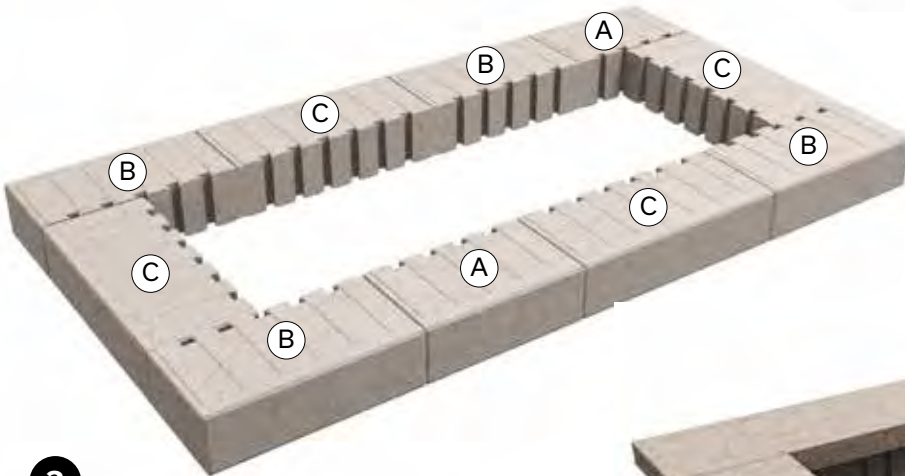

3

3rd row: proceed with installation by following this diagram

4

4th row: proceed with installation by repeating 2nd row diagram

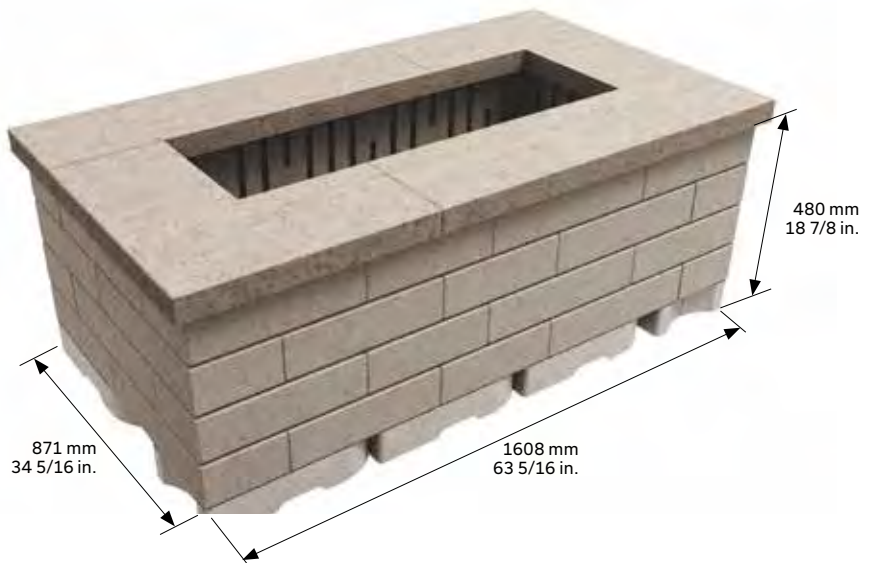

5

5th row: proceed with installation by repeating 3rd row diagram

6

Complete your firepit with Melville 60 caps